







Cutter RSC 170 PLUS

Part no.
1101568



-  **FORGED**
-  **360° HANDLE**
-  **PLUS**
-  **SINGLE**
-  **X-CHANGE**
-  **PUSH CONTROL**

Technical data:

Opening width	175 mm
Weight	15,4 kg
Dimensions (LxWxH)	732 x 236 x 164 mm
Nominal pressure	700 bar
EN cutting class (EN 13204)	BC166I-15,4
EN cutting performance (EN 13204)	1J-2K-3I-4J-5J
NFPA cutting class (NFPA 1936)	A7-B8-C6-D8-E9-F4

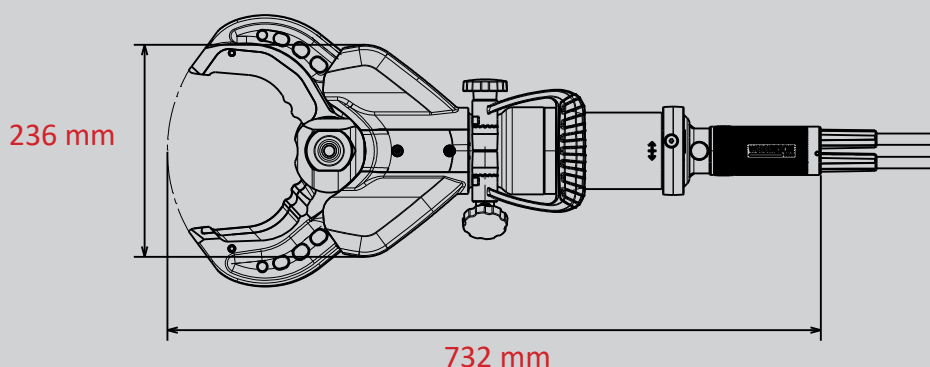
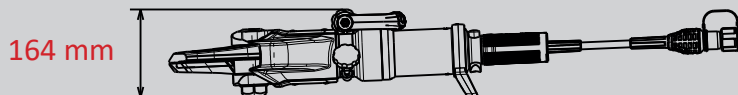

WEBER-HYDRAULIK GMBH
Heilbronner Straße 30
74363 Güglingen, Germany
Phone +49 7135 71-10270
info@weber-rescue.com

Emil Weber Platz 1
4460 Losenstein, Austria
Phone +43 7255 6237-120

Images are non-binding. We reserve the right to technical modifications.
2022B; 107/2022